

Interpreting the Benchmark Comparisons Report

To focus discussions about the importance of student engagement and to guide institutional improvement efforts, NSSE created five Benchmarks of Effective Educational Practice: Level of Academic Challenge, Active and Collaborative Learning, Student-Faculty Interaction, Enriching Educational Experiences, and Supportive Campus Environment. This Benchmark Comparisons Report compares the performance of your institution with your selected peers or consortium. In addition, page 9 provides two other comparisons between your school and (a) above-average institutions with benchmarks in the top 50% of all NSSE institutions and (b) high-performing institutions with benchmarks in the top 10% of all NSSE institutions. These displays allow you to determine if the engagement of your typical student differs in a statistically significant, meaningful way from the average student in these comparison groups. They also provide more insight into how the student experience varies on your campus and in comparison groups. More detailed information about how benchmarks are created can be found on the NSSE Web site at www.nsse.iub.edu/2009_Institutional_Report/.

Class and Sample

Means are reported for first-year students and seniors. Institution-reported class levels are used. All randomly selected students are included in these analyses. Students in targeted or locally administered oversamples are not included.

Statistical Significance

Benchmarks with mean differences that are larger than would be expected by chance alone are noted with one, two, or three asterisks, denoting one of three significance levels ($p < .05$, $p < .01$, and $p < .001$). The smaller the significance level, the smaller the likelihood that the difference is due to chance. Please note that statistical significance does not guarantee that the result is substantive or important. Large sample sizes (as with the NSSE project) tend to produce more statistically significant results even though the magnitude of mean differences may be inconsequential. It is recommended to consult effect sizes to judge the practical meaning of the results.

Effect Size^a

Effect size indicates the practical significance of the mean difference. It is calculated by dividing the mean difference by the pooled standard deviation. In practice, an effect size of .2 is often considered small, .5 moderate, and .8 large. A positive sign indicates that your institution's mean was greater, thus showing an affirmative result for the institution. A negative sign indicates the institution lags behind the comparison group, suggesting that the student behavior or institutional practice represented by the item may warrant attention.

Mean

The mean is the *weighted* arithmetic average of the student level benchmark scores.

Benchmark Description & Survey Items

A description of the benchmark and the individual items used in its creation is provided.

Box and Whiskers Key

A box and whiskers chart is a concise way to summarize the variation of student benchmark scores. This display compares the distribution of scores at your institution, in percentile terms, with that of your comparison groups. The ends of the whiskers show the 5th and 95th percentile scores, while the box is bounded by the 25th and 75th percentiles. The bar inside the box indicates the median score, and the dot shows the mean score.

Level of Academic Challenge (LAC)

Mean Comparisons

Class	NSSEville State University compared with:							
	NSSEville State	Mid East Public	Carnegie Class	NSSE 2009	NSSEville State	Mid East Public	Carnegie Class	NSSE 2009
First-Year	47.9	53.6 ***	-4.1	53.1 ***	-39	53.7	57.0 ***	-4.3
Senior	52.2	57.1 ***	-36	56.9	-33	57.0	57.0	-34

* Weighted by size, enrollment status, and institutional size.
** p < .05
*** p < .001 (2-tailed).
* Mean difference divided by the pooled standard deviation.

Distributions of Student Benchmark Scores

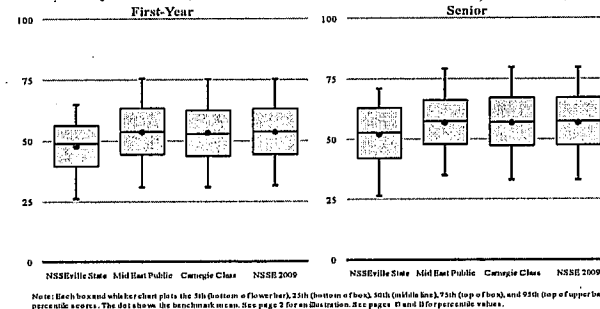

Level of Academic Challenge (LAC) Items

Challenging intellectual and creative work is central to student learning and collegiate quality. Colleges and universities promote high levels of student achievement by emphasizing the importance of academic effort and setting high expectations for student performance.

- Preparing for class (studying, reading, writing, doing homework or lab work, etc. related to academic program)
- Number of assigned textbooks, books, or book-length packs of course readings
- Number of written papers or reports of 20 pages or more; number of written papers or reports of between 5 and 19 pages; and number of written papers or reports of fewer than 5 pages
- Coursework emphasizes: Analysis of the basic elements of an idea, experience or theory
- Coursework emphasizes: Synthesis and organizing of ideas, information, or experiences into new, more complex interpretations and relationships
- Coursework emphasizes: Making judgments about the value of information, arguments, or methods
- Coursework emphasizes: Applying theories or concepts to practical problems or in new situations
- Working harder than you thought you could to meet an instructor's standards or expectations
- Campus environment emphasizes: Spending significant amount of time studying and on academic work.

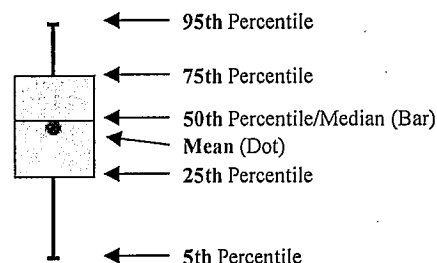

^a See *Contextualizing NSSE Effect Sizes* at www.nsse.iub.edu/pdf/effect_size_guide.pdf for additional information.

Level of Academic Challenge (LAC)

Mean Comparisons

Oklahoma State University compared with:

Class	OSU	Similar Land-Grant			Carnegie Class			NSSE 2009		
	Mean ^a	Mean ^a	Sig ^b	Effect Size ^c	Mean ^a	Sig ^b	Effect Size ^c	Mean ^a	Sig ^b	Effect Size ^c
First-Year	52.8	52.0		.06	53.5		-.05	53.7		-.06
Senior	53.5	55.2	***	-.12	56.6	***	-.21	57.1	***	-.25

^a Weighted by gender, enrollment status, and institutional size.

^b * p<.05 ** p<.01 ***p<.001 (2-tailed).

^c Mean difference divided by the pooled standard deviation.

Distributions of Student Benchmark Scores

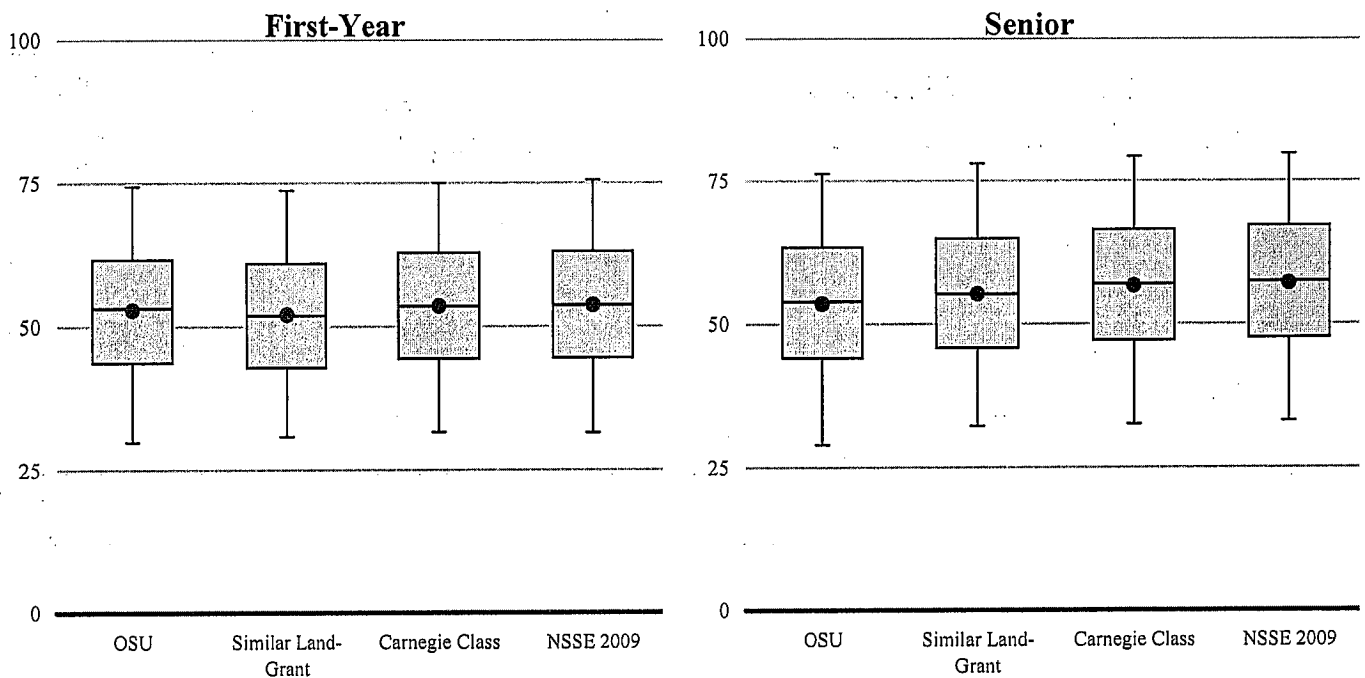

Note: Each box and whiskers chart plots the 5th (bottom of lower bar), 25th (bottom of box), 50th (middle line), 75th (top of box), and 95th (top of upper bar) percentile scores. The dot shows the benchmark mean. See page 2 for an illustration. See pages 10 and 11 for percentile values.

Level of Academic Challenge (LAC) Items

Challenging intellectual and creative work is central to student learning and collegiate quality. Colleges and universities promote high levels of student achievement by emphasizing the importance of academic effort and setting high expectations for student performance.

- Preparing for class (studying, reading, writing, doing homework or lab work, etc. related to academic program)
- Number of assigned textbooks, books, or book-length packs of course readings
- Number of written papers or reports of 20 pages or more; number of written papers or reports of between 5 and 19 pages; and number of written papers or reports of fewer than 5 pages
- Coursework emphasizes: **Analysis** of the basic elements of an idea, experience or theory
- Coursework emphasizes: **Synthesis** and organizing of ideas, information, or experiences into new, more complex interpretations and relationships
- Coursework emphasizes: **Making of judgments** about the value of information, arguments, or methods
- Coursework emphasizes: **Applying** theories or concepts to practical problems or in new situations
- Working harder than you thought you could to meet an instructor's standards or expectations
- Campus environment emphasizes: Spending significant amount of time studying and on academic work.

Active and Collaborative Learning (ACL)

Mean Comparisons

Oklahoma State University compared with:

Class	OSU	Similar Land-Grant			Carnegie Class			NSSE 2009		
	Mean ^a	Mean ^a	Sig ^b	Effect Size ^c	Mean ^a	Sig ^b	Effect Size ^c	Mean ^a	Sig ^b	Effect Size ^c
First-Year	41.0	40.7		.01	42.2		-.08	43.2	**	-.13
Senior	49.3	49.6		-.02	50.5	*	-.07	51.0	**	-.10

^a Weighted by gender, enrollment status, and institutional size.

^b * p<.05 ** p<.01 ***p<.001 (2-tailed).

^c Mean difference divided by the pooled standard deviation.

Distributions of Student Benchmark Scores

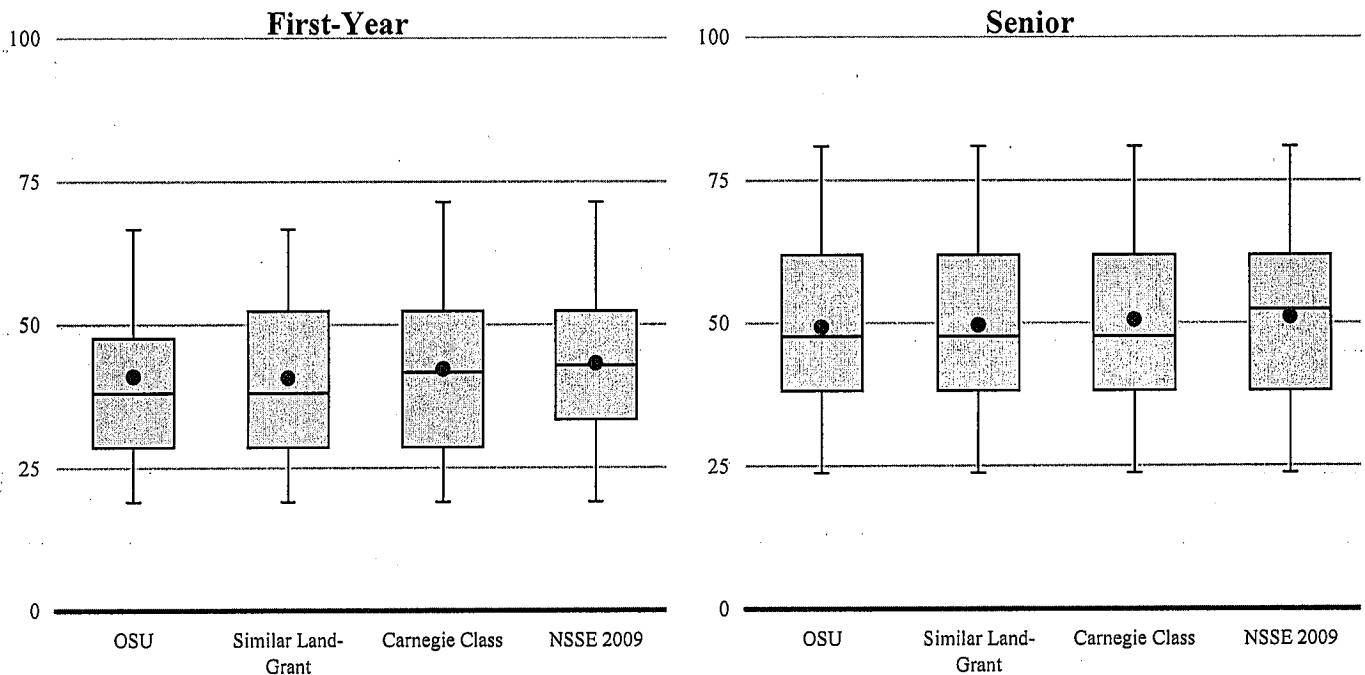

Note: Each box and whiskers chart plots the 5th (bottom of lower bar), 25th (bottom of box), 50th (middle line), 75th (top of box), and 95th (top of upper bar) percentile scores. The dot shows the benchmark mean. See page 2 for an illustration. See pages 10 and 11 for percentile values.

Active and Collaborative Learning (ACL) Items

Students learn more when they are intensely involved in their education and asked to think about what they are learning in different settings. Collaborating with others in solving problems or mastering difficult material prepares students for the messy, unscripted problems they will encounter daily during and after college.

- Asked questions in class or contributed to class discussions
- Made a class presentation
- Worked with other students on projects during class
- Worked with classmates outside of class to prepare class assignments
- Tutored or taught other students (paid or voluntary)
- Participated in a community-based project (e.g., service learning) as part of a regular course
- Discussed ideas from your readings or classes with others outside of class (students, family members, co-workers, etc.)

Student-Faculty Interaction (SFI)

Mean Comparisons

Oklahoma State University compared with:

Class	OSU	Similar Land-Grant			Carnegie Class			NSSE 2009		
	Mean ^a	Mean ^a	Sig ^b	Effect Size ^c	Mean ^a	Sig ^b	Effect Size ^c	Mean ^a	Sig ^b	Effect Size ^c
First-Year	35.5	32.1	***	.19	33.3	*	.12	34.6		.04
Senior	41.0	41.4		-.02	40.9		.01	42.0		-.04

^a Weighted by gender, enrollment status, and institutional size.

^b * p<.05 ** p<.01 ***p<.001 (2-tailed).

^c Mean difference divided by the pooled standard deviation.

Distributions of Student Benchmark Scores

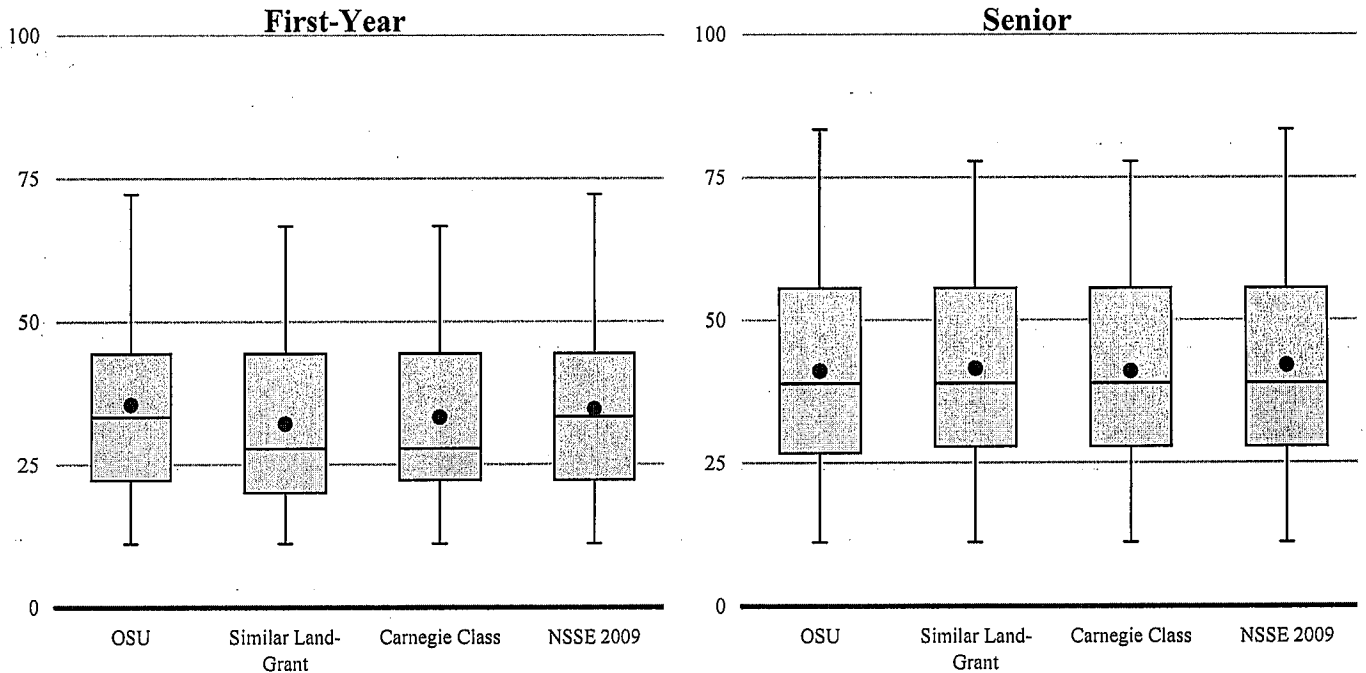

Note: Each box and whiskers chart plots the 5th (bottom of lower bar), 25th (bottom of box), 50th (middle line), 75th (top of box), and 95th (top of upper bar) percentile scores. The dot shows the benchmark mean. See page 2 for an illustration. See pages 10 and 11 for percentile values.

Student-Faculty Interaction (SFI) Items

Students learn firsthand how experts think about and solve practical problems by interacting with faculty members inside and outside the classroom. As a result, their teachers become role models, mentors, and guides for continuous, life-long learning.

- Discussed grades or assignments with an instructor
- Talked about career plans with a faculty member or advisor
- Discussed ideas from your readings or classes with faculty members outside of class
- Worked with faculty members on activities other than coursework (committees, orientation, student-life activities, etc.)
- Received prompt written or oral feedback from faculty on your academic performance
- Worked on a research project with a faculty member outside of course or program requirements

Enriching Educational Experiences (EEE)

Mean Comparisons

Oklahoma State University compared with:

Class	OSU	Similar Land-Grant			Carnegie Class			NSSE 2009		
	Mean ^a	Mean ^a	Sig ^b	Effect Size ^c	Mean ^a	Sig ^b	Effect Size ^c	Mean ^a	Sig ^b	Effect Size ^c
First-Year	27.9	28.9		-.08	28.0		-.01	28.0		-.01
Senior	40.6	42.8	***	-.13	40.8		-.01	40.8		-.02

^a Weighted by gender, enrollment status, and institutional size.

^b * p<.05 ** p<.01 ***p<.001 (2-tailed).

^c Mean difference divided by the pooled standard deviation.

Distributions of Student Benchmark Scores

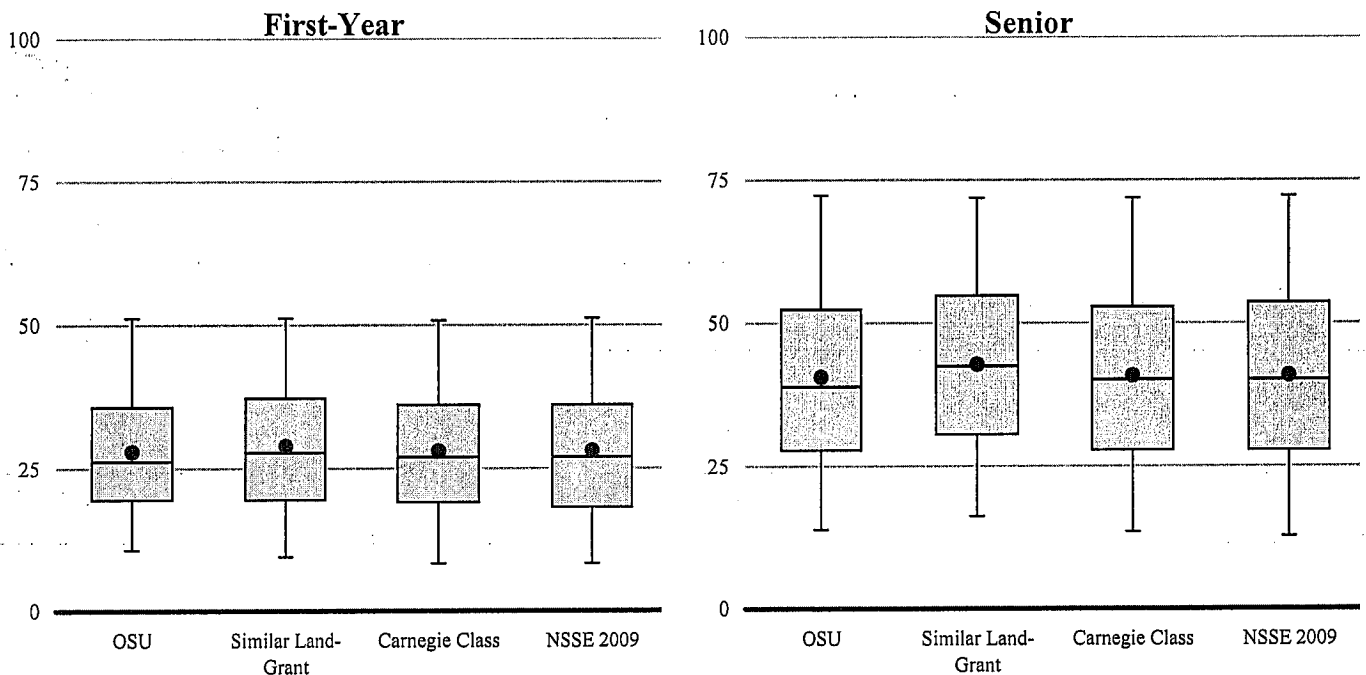

Note: Each box and whiskers chart plots the 5th (bottom of lower bar), 25th (bottom of box), 50th (middle line), 75th (top of box), and 95th (top of upper bar) percentile scores. The dot shows the benchmark mean. See page 2 for an illustration. See pages 10 and 11 for percentile values.

Enriching Educational Experiences (EEE) Items

Complementary learning opportunities enhance academic programs. Diversity experiences teach students valuable things about themselves and others. Technology facilitates collaboration between peers and instructors. Internships, community service, and senior capstone courses provide opportunities to integrate and apply knowledge.

- Participating in co-curricular activities (organizations, campus publications, student government, social fraternity or sorority, etc.)
- Practicum, internship, field experience, co-op experience, or clinical assignment
- Community service or volunteer work
- Foreign language coursework / Study abroad
- Independent study or self-designed major
- Culminating senior experience (capstone course, senior project or thesis, comprehensive exam, etc.)
- Serious conversations with students of different religious beliefs, political opinions, or personal values
- Serious conversations with students of a different race or ethnicity than your own
- Using electronic medium (e.g., listserv, chat group, Internet, instant messaging, etc.) to discuss or complete an assignment
- Campus environment encouraging contact among students from different economic, social, and racial or ethnic backgrounds
- Participate in a learning community or some other formal program where groups of students take two or more classes together

Supportive Campus Environment (SCE)

Mean Comparisons

Oklahoma State University compared with:

Class	OSU	Similar Land-Grant			Carnegie Class			NSSE 2009		
	Mean ^a	Mean ^a	Sig ^b	Effect Size ^c	Mean ^a	Sig ^b	Effect Size ^c	Mean ^a	Sig ^b	Effect Size ^c
First-Year	62.2	61.7		.03	60.1	*	.11	61.6		.03
Senior	56.8	57.4		-.03	56.7		.00	58.2	*	-.08

^a Weighted by gender, enrollment status, and institutional size.

^b * p<.05 ** p<.01 ***p<.001 (2-tailed).

^c Mean difference divided by the pooled standard deviation.

Distributions of Student Benchmark Scores

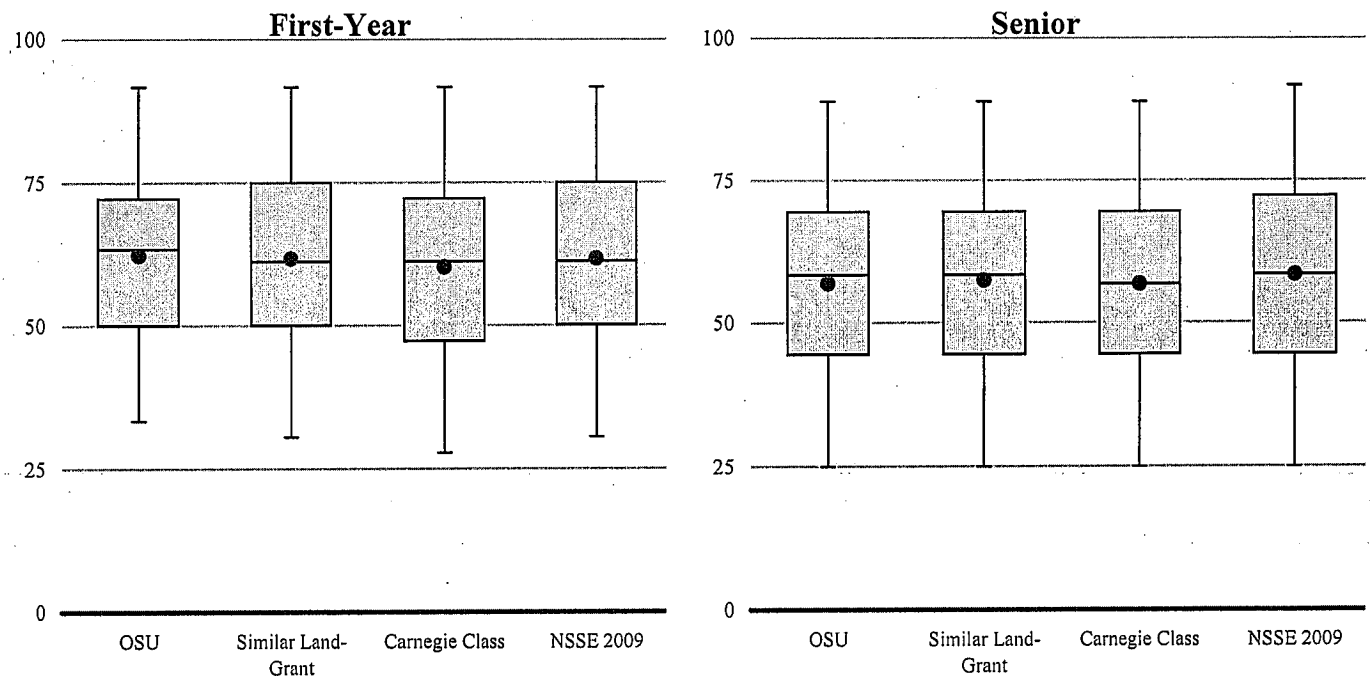

Note: Each box and whiskers chart plots the 5th (bottom of lower bar), 25th (bottom of box), 50th (middle line), 75th (top of box), and 95th (top of upper bar) percentile scores. The dot shows the benchmark mean. See page 2 for an illustration. See pages 10 and 11 for percentile values.

Supportive Campus Environment (SCE) Items

Students perform better and are more satisfied at colleges that are committed to their success and cultivate positive working and social relations among different groups on campus.

- Campus environment provides the support you need to help you succeed academically
- Campus environment helps you cope with your non-academic responsibilities (work, family, etc.)
- Campus environment provides the support you need to thrive socially
- Quality of relationships with other students
- Quality of relationships with faculty members
- Quality of relationships with administrative personnel and offices

Interpreting the Top 10% and Top 50% Comparisons

This section of the NSSE Benchmark Comparisons report allows you to estimate the performance of your average student in relation to the average student attending two different institutional peer groups identified by NSSE for their high levels of student engagement: (a) those with benchmark scores placing them in the top 50% of all NSSE schools in 2009 and (b) those with benchmark scores in the top 10% for 2009.^a These comparisons allow an institution to determine if the engagement of their students differs in significant, meaningful ways from students in these high performing peer groups.

Example

NSSEville State compared with

	NSSEville State	NSSE 2009					
		Top 50%			Top 10%		
		<i>Mean</i>	<i>Sig</i>	<i>Effect size</i>	<i>Mean</i>	<i>Sig</i>	<i>Effect size</i>
First-Year	LAC	57.1			60.5	***	-0.28
	ACL	50.3		.28	50.7		-0.02
	SFI	37.3		.01	42.0	***	-0.24
	EEE	21.8	***	-.63	34.4	***	-0.98
	SCE	60.9	***	-.21	69.7	***	-0.49

NSSEville State CAN conclude...

- ◆ The average score for NSSEville State first-year students is slightly above (i.e., small positive effect size) that of the average student attending NSSE 2009 schools that scored in the top 50% on Level of Academic Challenge (LAC).
- ◆ The average NSSEville State first-year student is as engaged (i.e., not significantly different) as the average student attending NSSE 2009 schools that scored in the top 10% on Active and Collaborative Learning (ACL).
- ◆ It is *likely* that NSSEville State is in the top 50% of all NSSE 2009 schools for first-year students on Level of Academic Challenge (LAC) and Active and Collaborative Learning (ACL).^a

NSSEville State CANNOT conclude^a...

- ◆ NSSEville State is in the top half of all schools on the Student-Faculty Interaction (SFI) benchmark for first-year students.^a
- ◆ NSSEville State is a "top ten percent" institution on Active and Collaborative Learning (ACL) for first-year students.^a

For additional information on how to understand and use the Top 50% and Top 10% section of the benchmark report, see www.nsse.iub.edu/2009_Institutional_Report/.

^a Precision-weighted means (produced by Hierarchical Linear Modeling) were used to determine the top 50% and top 10% institutions for each benchmark, separately for first-year and senior students. Using this method, benchmark scores of institutions with relatively large standard errors are adjusted substantially toward the grand mean of all students, while those with smaller standard errors receive smaller corrections. Thus, schools with less stable data, though they may have high scores, may not be identified among the top scorers. NSSE does not publish the names of the top 50% and top 10% institutions because of our commitment not to release individual school results and our policy against the ranking of institutions.



OSU compared with

	OSU Mean ^a	NSSE 2009 Top 50%			NSSE 2009 Top 10%			
		Mean ^a	Sig ^b	Effect size ^c	Mean ^a	Sig ^b	Effect size ^c	
First-Year	LAC	52.8	56.8	***	-.31	58.9	***	-.47
	ACL	41.0	47.8	***	-.41	51.7	***	-.62
	SFI	35.5	39.1	***	-.19	43.7	***	-.40
	EEE	27.9	31.0	***	-.23	32.8	***	-.36
	SCE	62.2	66.2	***	-.22	69.1	***	-.38
Senior	LAC	53.5	60.1	***	-.48	62.8	***	-.69
	ACL	49.3	55.7	***	-.38	59.1	***	-.57
	SFI	41.0	48.8	***	-.36	54.2	***	-.60
	EEE	40.6	48.1	***	-.42	54.2	***	-.79
	SCE	56.8	64.1	***	-.39	67.5	***	-.58

Level of Academic Challenge
(LAC)

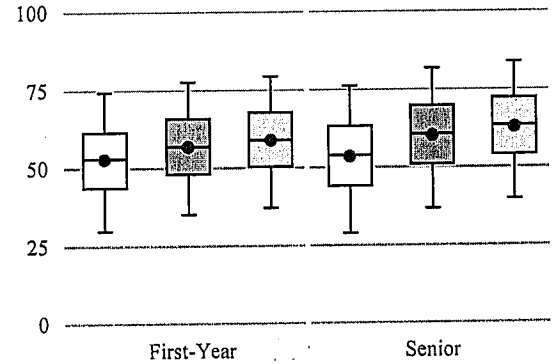

Active and Collaborative Learning
(ACL)

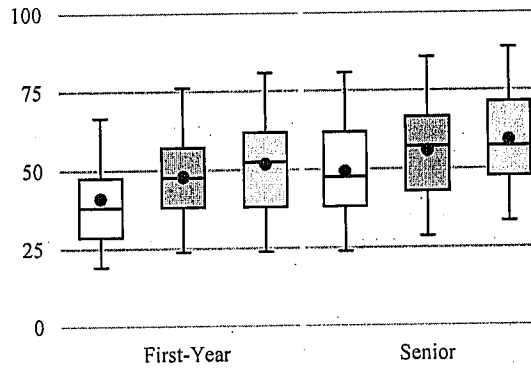

Student-Faculty Interaction
(SFI)

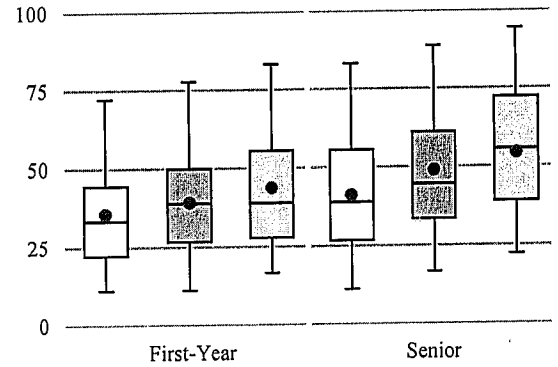

Enriching Educational Experiences
(EEE)

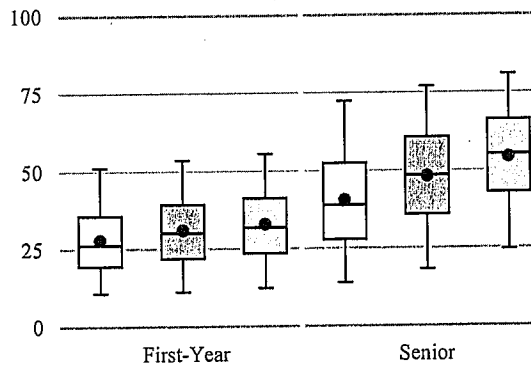

Supportive Campus Environment
(SCE)

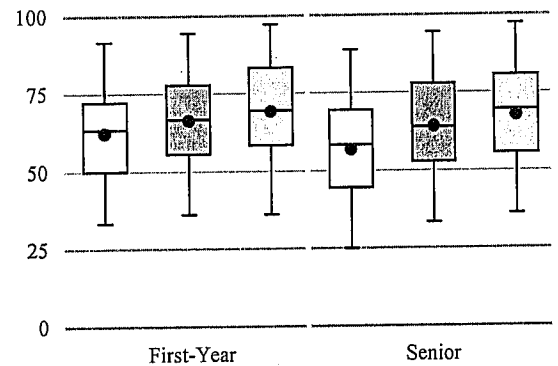

Legend

- OSU
- Top 50%
- Top 10%

This display compares your students with those attending schools that scored in the top 50% and top 10% of all NSSE 2009 institutions on a particular benchmark.

Note: Each box and whiskers chart plots the 5th (bottom of lower bar), 25th (bottom of box), 50th (middle line), 75th (top of box), and 95th (top of upper bar) percentile scores. The dot shows the benchmark mean. See page 2 for an illustration. See pages 10 and 11 for percentile values.

^a Weighted by gender, enrollment status, and institutional size.

^b * p<.05 ** p<.01 ***p<.001 (2-tailed).

^c Mean difference divided by the pooled standard deviation.

First-Year Students

	Mean Statistics			Distribution Statistics					Reference Group Comparison Statistics			
	Mean	SD ^b	SEM ^c	Percentiles ^d					Deg. of Freedom ^e	Mean Diff.	Sig. ^f	Effect size ^g
	5th	25th	50th	75th	95th							
LEVEL OF ACADEMIC CHALLENGE (LAC)												
OSU (N = 422)	52.8	13.1	.6	30	44	53	62	74				
Similar Land-Grant	52.0	13.1	.1	31	43	52	61	74	9,692	.8	.242	.06
Carnegie Class	53.5	13.4	.1	32	44	53	63	75	23,439	-.7	.293	-.05
NSSE 2009	53.7	13.5	.0	32	44	54	63	75	114,194	-.9	.186	-.06
Top 50%	56.8	13.0	.1	35	48	57	66	78	43,917	-4.0	.000	-.31
Top 10%	58.9	12.9	.1	37	50	59	68	79	12,217	-6.1	.000	-.47
ACTIVE AND COLLABORATIVE LEARNING (ACL)												
OSU (N = 474)	41.0	15.5	.7	19	29	38	48	67				
Similar Land-Grant	40.7	16.0	.2	19	29	38	52	67	10,799	.2	.760	.01
Carnegie Class	42.2	16.5	.1	19	29	42	52	71	25,402	-1.3	.101	-.08
NSSE 2009	43.2	16.6	.0	19	33	43	52	71	124,111	-2.2	.004	-.13
Top 50%	47.8	16.6	.1	24	38	48	57	76	487	-6.8	.000	-.41
Top 10%	51.7	17.5	.2	24	38	52	62	81	548	-10.7	.000	-.62
STUDENT-FACULTY INTERACTION (SFI)												
OSU (N = 431)	35.5	17.7	.9	11	22	33	44	72				
Similar Land-Grant	32.1	17.7	.2	11	20	28	44	67	9,800	3.3	.000	.19
Carnegie Class	33.3	18.3	.1	11	22	28	44	67	23,647	2.2	.013	.12
NSSE 2009	34.6	18.4	.1	11	22	33	44	72	115,382	.8	.360	.04
Top 50%	39.1	19.2	.1	11	27	39	50	78	443	-3.6	.000	-.19
Top 10%	43.7	20.6	.3	17	28	39	56	83	526	-8.2	.000	-.40
ENRICHING EDUCATIONAL EXPERIENCES (EEE)												
OSU (N = 405)	27.9	12.7	.6	11	19	26	36	51				
Similar Land-Grant	28.9	13.1	.1	10	19	28	37	51	9,457	-1.0	.131	-.08
Carnegie Class	28.0	13.3	.1	8	19	27	36	51	22,853	-.1	.839	-.01
NSSE 2009	28.0	13.4	.0	8	18	27	36	51	111,232	-.1	.834	-.01
Top 50%	31.0	13.4	.1	11	22	30	39	54	49,621	-3.1	.000	-.23
Top 10%	32.8	13.7	.1	12	23	32	41	56	15,890	-4.9	.000	-.36
SUPPORTIVE CAMPUS ENVIRONMENT (SCE)												
OSU (N = 397)	62.2	16.8	.8	33	50	63	72	92				
Similar Land-Grant	61.7	17.9	.2	31	50	61	75	92	438	.5	.542	.03
Carnegie Class	60.1	18.7	.1	28	47	61	72	92	414	2.1	.016	.11
NSSE 2009	61.6	18.8	.1	31	50	61	75	92	400	.6	.454	.03
Top 50%	66.2	18.1	.1	36	56	67	78	94	407	-4.0	.000	-.22
Top 10%	69.1	18.3	.2	36	58	69	83	97	445	-7.0	.000	-.38

^a All statistics are weighted by gender, enrollment status, and institutional size.

^b Standard deviation is a measure of the average amount the individual scores deviate from the mean of all the scores in the distribution.

^c The 95% confidence interval for the population mean is equal to the sample mean plus/minus 1.96 times the standard error of the mean.

^d A percentile is the point in the distribution of student-level benchmark scores at or below which a given percentage of benchmark scores fall.

^e Degrees of freedom used to compute the t-tests. Values vary for the total Ns due to weighting and the equal variance assumption.

^f Statistical significance represents the probability that the difference between the mean of your institution and that of the comparison group occurred by chance.

^g Effect size is calculated by subtracting the comparison group mean from the school mean, and dividing the result by the pooled standard deviation.

Seniors

	Mean Statistics			Distribution Statistics					Reference Group Comparison Statistics			
	Mean	SD ^b	SEM ^c	Percentiles ^d					Deg. of Freedom ^e	Mean Diff.	Sig. ^f	Effect size ^g
	5th	25th	50th	75th	95th							
LEVEL OF ACADEMIC CHALLENGE (LAC)												
OSU (N = 866)	53.5	14.4	.5	29	44	54	63	76				
Similar Land-Grant	55.2	14.0	.1	32	46	55	65	78	14,959	-1.7	.001	-.12
Carnegie Class	56.6	14.2	.1	33	47	57	66	79	36,615	-3.0	.000	-.21
NSSE 2009	57.1	14.3	.0	33	48	57	67	80	169,312	-3.5	.000	-.25
Top 50%	60.1	13.7	.1	37	51	61	70	82	53,713	-6.6	.000	-.48
Top 10%	62.8	13.3	.1	40	54	63	72	84	986	-9.3	.000	-.69
ACTIVE AND COLLABORATIVE LEARNING (ACL)												
OSU (N = 936)	49.3	16.8	.6	24	38	48	62	81				
Similar Land-Grant	49.6	16.9	.1	24	38	48	62	81	15,949	-.3	.561	-.02
Carnegie Class	50.5	17.2	.1	24	38	48	62	81	38,545	-1.2	.034	-.07
NSSE 2009	51.0	17.4	.0	24	38	52	62	81	177,772	-1.8	.002	-.10
Top 50%	55.7	16.9	.1	29	43	57	67	86	48,827	-6.5	.000	-.38
Top 10%	59.1	17.2	.2	33	48	57	71	89	11,084	-9.8	.000	-.57
STUDENT-FACULTY INTERACTION (SFI)												
OSU (N = 882)	41.0	20.9	.7	11	27	39	56	83				
Similar Land-Grant	41.4	20.4	.2	11	28	39	56	78	15,059	-.4	.592	-.02
Carnegie Class	40.9	20.7	.1	11	28	39	56	78	36,878	.1	.873	.01
NSSE 2009	42.0	20.9	.1	11	28	39	56	83	170,572	-.9	.186	-.04
Top 50%	48.8	21.3	.1	17	33	44	61	89	39,069	-7.7	.000	-.36
Top 10%	54.2	22.0	.3	22	39	56	72	94	1,178	-13.1	.000	-.60
ENRICHING EDUCATIONAL EXPERIENCES (EEE)												
OSU (N = 844)	40.6	17.9	.6	14	28	39	52	72				
Similar Land-Grant	42.8	17.1	.1	16	31	42	55	72	14,654	-2.2	.000	-.13
Carnegie Class	40.8	17.9	.1	13	28	40	53	72	35,956	-.2	.702	-.01
NSSE 2009	40.8	18.2	.0	13	28	40	54	72	166,071	-.3	.645	-.02
Top 50%	48.1	17.8	.1	18	36	48	61	77	52,901	-7.5	.000	-.42
Top 10%	54.2	17.1	.2	25	43	55	66	81	966	-13.6	.000	-.79
SUPPORTIVE CAMPUS ENVIRONMENT (SCE)												
OSU (N = 831)	56.8	18.7	.6	25	44	58	69	89				
Similar Land-Grant	57.4	18.8	.2	25	44	58	69	89	14,379	-.6	.379	-.03
Carnegie Class	56.7	19.2	.1	25	44	57	69	89	35,313	.1	.917	.00
NSSE 2009	58.2	19.3	.0	25	44	58	72	92	163,129	-1.5	.029	-.08
Top 50%	64.1	18.8	.1	33	53	64	78	94	44,872	-7.3	.000	-.39
Top 10%	67.5	18.5	.2	36	56	69	81	97	11,550	-10.8	.000	-.58

^a All statistics are weighted by gender, enrollment status, and institutional size.

^b Standard deviation is a measure of the average amount the individual scores deviate from the mean of all the scores in the distribution.

^c The 95% confidence interval for the population mean is equal to the sample mean plus/minus 1.96 times the standard error of the mean.

^d A percentile is the point in the distribution of student-level benchmark scores at or below which a given percentage of benchmark scores fall.

^e Degrees of freedom used to compute the t-tests. Values vary for the total Ns due to weighting and the equal variance assumption.

^f Statistical significance represents the probability that the difference between the mean of your institution and that of the comparison group occurred by chance.

^g Effect size is calculated by subtracting the comparison group mean from the school mean, and dividing the result by the pooled standard deviation.